

► aysam

# Ortopedik Cerrahi Aletler



 aysam

#### Instrumentation for Austin Moore Hip Prosthesis



A550 01 091 0111 AO-INS-111 Moore Rasp for Standard Stem 8698823347475  
 A550 01 091 0112 AO-INS-112 Moore Rasp for Narrow Stem 8698823347482



A550 01 091 0117 AO-INS-117 Mortising chisel 8698823347529



A550 01 091 0120 AO-INS-120 Prosthesis extractor 8698823347543

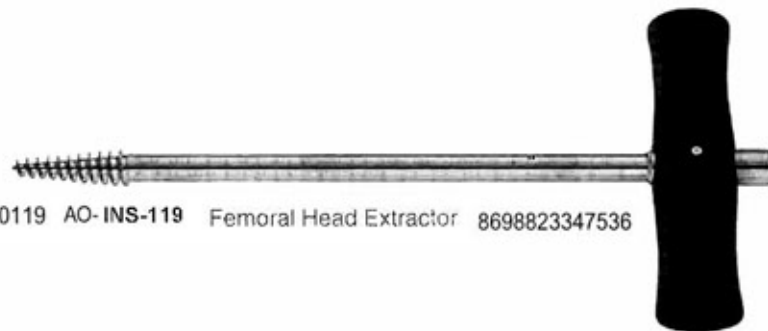

A550 01 091 0119 AO-INS-119 Femoral Head Extractor 8698823347536



A550 01 091 0114 AO-INS-114 Prosthesis Driver 8698823347505  
 A550 01 091 0115 AO-INS-114A Head Only 8698823347512



A550 01 091 0113 AO-INS-113 Murray Lane Bone Skid 8698823347499



A550 01 091 0211 AO-INS-211 Drill Bits with end to fit quick coupling  $\phi$  3.2 mm 8698823347550  
 A550 01 091 0212 AO-INS-212 Drill Bits with end to fit quick coupling  $\phi$  4.5 mm 8698823347567

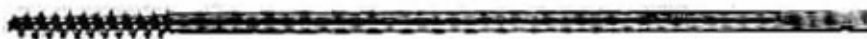

A550 01 091 0213 AO-INS-213 Tap,  $\phi$  6.5 mm 8698823347574



A550 01 091 0214 AO-INS-214 Tap,  $\phi$  4.5 mm 8698823347581

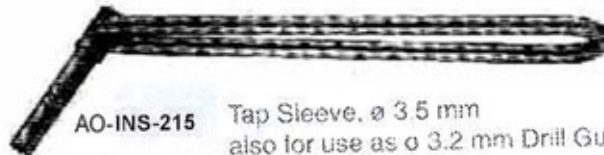

AO-INS-215 Tap Sleeve,  $\phi$  3.5 mm 8698823347598  
 also for use as  $\phi$  3.2 mm Drill Guide  
 A550 01 091 0215

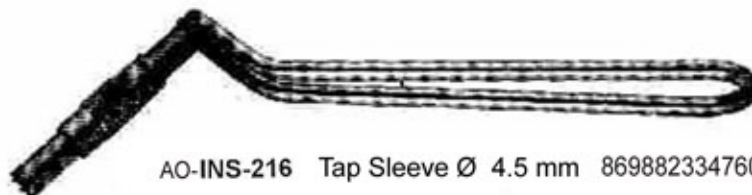

AO-INS-216 Tap Sleeve  $\phi$  4.5 mm 8698823347604  
 A550 01 091 0216



AO-INS-217 Drill Sleeve for Round Hole Plates  
 A550 01 091 0217 8698823347611

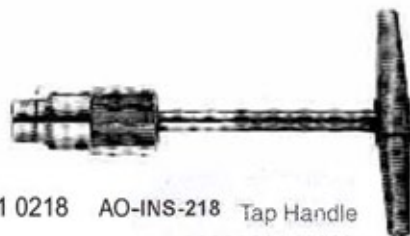

A550 01 091 0218 AO-INS-218 Tap Handle  
8698823347628



AO-INS-219 Countersink,  $\phi$  4.5 mm tip 8698823347635  
A550 01 091 0219



AO-INS-220 Neutral and Load Drill Guide  $\phi$  3.2 mm 8698823347642  
A550 01 091 0220

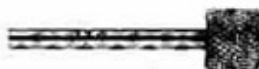

AO-INS-221 Insert Drill Sleeve 4.5 mm / 3.2 mm 8698823347659  
A550 01 091 0221 for 3.2 mm  $\phi$  Drill Bit

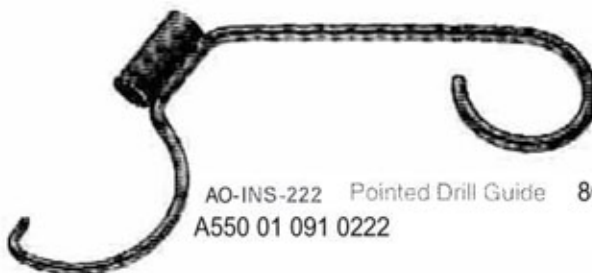

AO-INS-222 Pointed Drill Guide 8698823347666  
A550 01 091 0222

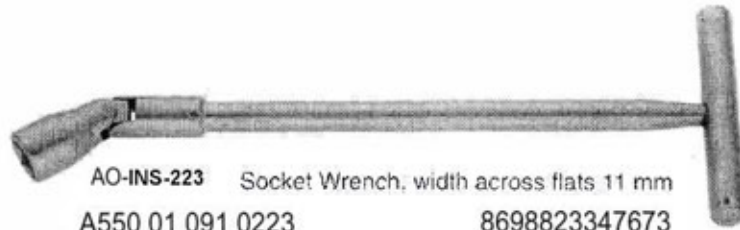

AO-INS-223 Socket Wrench, width across flats 11 mm  
A550 01 091 0223 8698823347673



AO-INS-224 Malleolar Countersink 8698823347680  
A550 01 091 0224

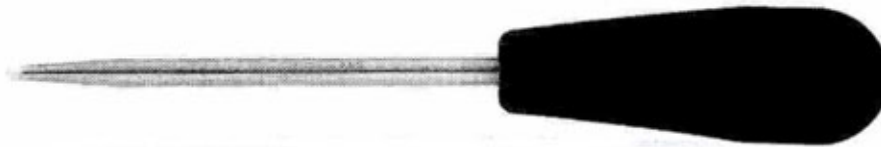

A550 01 091 0225 AO-INS-225 Hexagonal Screwdriver,  
width across flats 3.5 mm  
8698823347697



AO-INS-226 Hexagonal Screwdriver for quick coupling width across flats 3.5 mm  
A550 01 091 0226 8698823347703

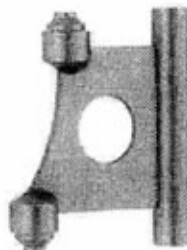

AO-INS-227 Drill Sleeve for Tension Device  
A550 01 091 0227 8698823347710

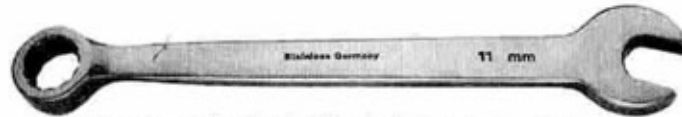

AO-INS-228 Combination Wrench width across flats 11 mm  
 A550 01 091 0228 8698823347727



AO-INS-229 Depth Gauge for 4.5 mm and 6.5 mm  $\phi$  screws  
 A550 01 091 0229 8698823347734



AO-INS-231 Screw Forceps 8698823347758  
 A550 01 091 0231



AO-INS-231 Screw Forceps 8698823347758  
 A550 01 091 0231



A550 01 091 0232	AO-INS-232	Bending Template 5 holes	8698823347765
A550 01 091 0233	AO-INS-233	Bending Template 7 holes	8698823347772
A550 01 091 0234	AO-INS-234	Bending Template 9 holes	8698823347789

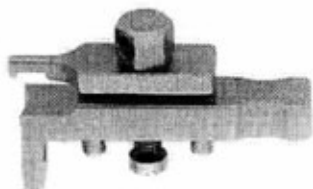

**AO-INS-235** 8 mm screw-type  
A550 01 091 0235  
8698823347796  
Compression Device

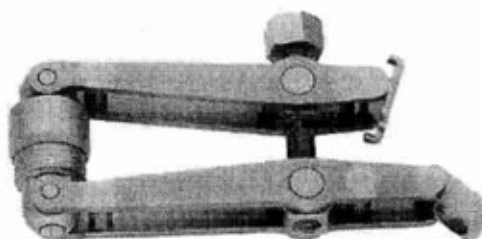

**AO-INS-236** Articulated Tension Device with Indicator, span 20 mm  
A550 01 091 0236  
8698823347802  
May also be used for distraction of standard and small plates

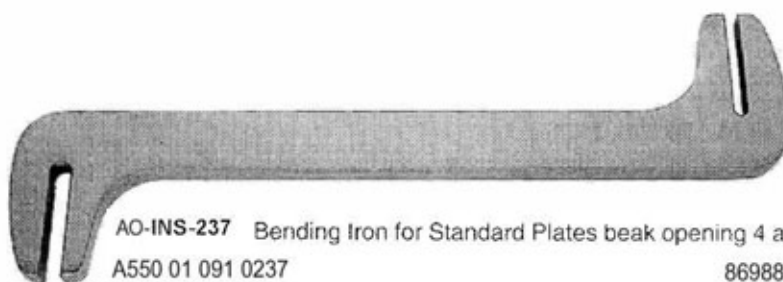

**AO-INS-237** Bending Iron for Standard Plates beak opening 4 and 6 mm  
A550 01 091 0237  
8698823347819



**AO-INS-238** Pin Wrench for Tension Device and Distractor  
A550 01 091 0238  
8698823347826

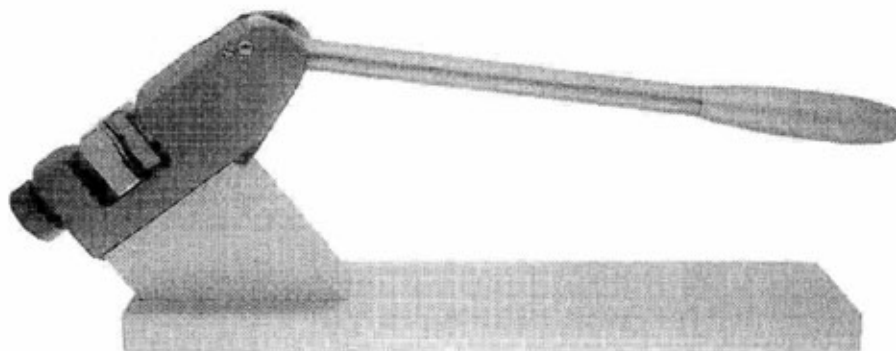

**AO-INS-239** Bending Device to bend straight and angled plates  
A550 01 091 0239  
8698823347833

#### Small Fragment Instruments



		Taps		
A550 01 091 0300	AO-INS-300	3.5 mm $\phi$ / 1.25 mm pitch, cortex		8698823347840
A550 01 091 0301	AO-INS-301	3.5 mm $\phi$ / 1.75 mm pitch cancellous		8698823347857
A550 01 091 0302	AO-INS-302	4.0 mm $\phi$ / 1.75 mm pitch		8698823347864



A550 01 091 0303	AO-INS-303	Tap Handle with quick coupling	8698823347871
------------------	------------	--------------------------------	---------------



A550 01 091 0304	AO-INS-304	Drill Guide and Drill Sleeve For 2.0 mm $\phi$ drill bit	8698823347888
------------------	------------	---	---------------

A550 01 091 0305 8698823347895  
A550 01 091 0306 8698823347901

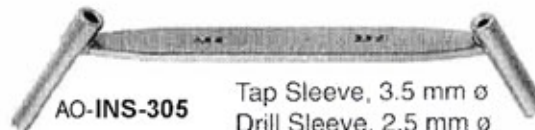

AO-INS-305	Tap Sleeve, 3.5 mm $\phi$ Drill Sleeve, 2.5 mm $\phi$
AO-INS-306	Tap Sleeve, 2.0 mm $\phi$ Drill Sleeve, 2.7 mm $\phi$



A550 01 091 0307 8698823347918	AO-INS-307	Neutral and Load Drill Guide, 3.5 mm For 3.5 mm cortex screws with fine thread, used with 2.5 mm $\phi$ Drill Guide
-----------------------------------	------------	---



### Small Fragment Instruments



AO-INS-308 Drill Bits with end to fit quick coupling  
2.5 mm  $\varnothing$   
AO-INS-309 3.5 mm  $\varnothing$

A550 01 091 0308 8698823347925  
A550 01 091 0309 8698823347932



AO-INS-310 Small Countersink  
A550 01 091 0310 8698823347949



AO-INS-311 Small Hexagonal Screw Driver with Holding Sleeve  
A550 01 091 0311 8698823347956



AO-INS-312 Small Hexagonal Screw Driver with end to fit quick coupling  
A550 01 091 0312 8698823347963



SE-INS-313 Insert Drill Sleeve, 3.5 mm / 2.5 mm  $\varnothing$



AO-INS-313 Insert Drill Sleeve, 3.5 mm / 2.5 mm  $\varnothing$   
A550 01 091 0313 8698823347970



A550 01 091 0315 AO-INS-315 Small Hohmann Retractor 6 mm 8698823347994  
A550 01 091 0316 AO-INS-316 Small Hohmann Retractor 8 mm 8698823348007

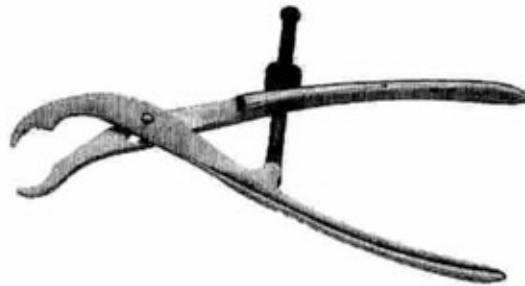

AO-INS-317 Self-Centering Bone Holding Forceps  
A550 01 091 0317 8698823348014

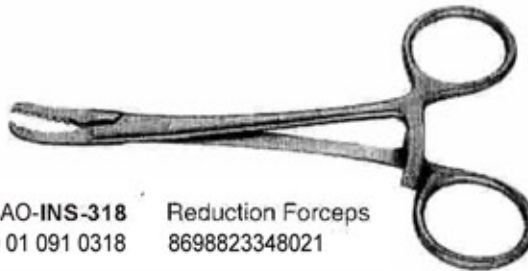

AO-INS-318 Reduction Forceps  
A550 01 091 0318 8698823348021

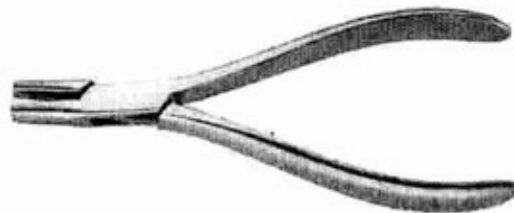

AO-INS-319 Bending Pliers for 2.7 and 3.5 mm plates  
A550 01 091 0319 8698823348038



AO-INS-320 Hohmann Retractor with broad shank  
A550 01 091 0320 8698823348045

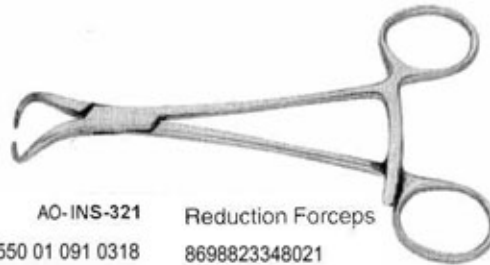

AO-INS-321 Reduction Forceps  
A550 01 091 0318 8698823348021



AO-INS-322 Depth Gauge for 2.7 - 4.0 mm ø screws  
A550 01 091 0322 8698823348069



AO-INS-323 Screw Forceps self holding  
A550 01 091 0323 8698823348076



AO-INS-324 Sharp Hook  
A550 01 091 0324 8698823348083



AO-INS-325 Bending Template for small plates 7 holes  
AO-INS-326 Bending Template for small plates 9 holes  
A550 01 091 0325 8698823348090  
A550 01 091 0326 8698823348106



AO-INS-327 Bending Iron for Small Plate  
A550 01 091 0327 8698823348113



AO-INS-328 Bending Irons for small plates to be used as a pair  
A550 01 091 0328 8698823348120

#### Mini Fragment Combined Instruments and Implant Set

Instruments for 1.5 and 2.0 mm  $\phi$  Screw



A550 01 091 0400	AO-INS-400	Tap 1.5 mm $\phi$ (Dental)	8698823348137
A550 01 091 0401	AO-INS-401	Tap 2.0 mm $\phi$ (Dental)	8698823348144
A550 01 091 0402	AO-INS-402	Tap 2.7 mm $\phi$	8698823348151



		Drill Bit with end to fit quick coupling	
A550 01 091 0403	AO-INS-403	1.1 mm $\phi$	8698823348168
A550 01 091 0404	AO-INS-404	1.5 mm $\phi$	8698823348175
A550 01 091 0405	AO-INS-405	2.0 mm $\phi$	8698823348182
A550 01 091 0406	AO-INS-406	2.7 mm $\phi$	8698823348199



	AO-INS-407	Mini Countersink	
A550 01 091 0407			8698823348205



	AO-INS-408	Depth Gauge for 1.5 mm and 2.0 mm $\phi$ screws	
A550 01 091 0408			8698823348212



	AO-INS-409	Mini Drill Sleeve for 1.1 mm and 1.5 mm $\phi$ drill bits	
	AO-INS-410	Mini Drill Sleeve for 1.5 mm and 2.0 mm $\phi$ drill bits	
A550 01 091 0409			8698823348229
A550 01 091 0410			8698823348236



	AO-INS-411	Small Countersink with end to fit quick coupling	
A550 01 091 0411			8698823348243



AO-INS-412 Tap Handle with dental coupling  
A550 01 091 0412 8698823348250



AO-INS-413 Tap Handle with quick coupling  
A550 01 091 0413 8698823348267



AO-INS-414 Small Hexagonal Screwdriver 1.5 mm with holding sleeve  
AO-INS-415 2.5 mm with holding sleeve  
A550 01 091 0414 8698823348274  
A550 01 091 0415 8698823348281



AO-INS-416 Periosteal Elevator  
A550 01 091 0416 8698823348298



AO-INS-417 Depth Gauge for 2.7 - 4.0 mm ø screws  
A550 01 091 0417 8698823348304

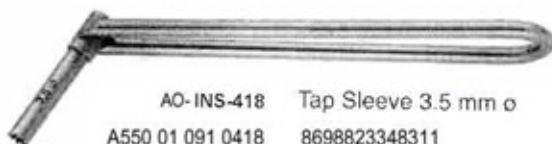

AO-INS-418 Tap Sleeve 3.5 mm ø  
A550 01 091 0418 8698823348311



AO-INS-419 Sharp Hook  
A550 01 091 0419 8698823348328



AO-INS-420 Drill Guide and Drill Sleeve for 2.0 mm  $\phi$  drill bit  
 A550 01 091 0420 8698823348335



AO-INS-421 Bending Iron  
 A550 01 091 0421 8698823348342



AO-INS-422 Hohmann Retractor with broad shank  
 A550 01 091 0422 8698823348359

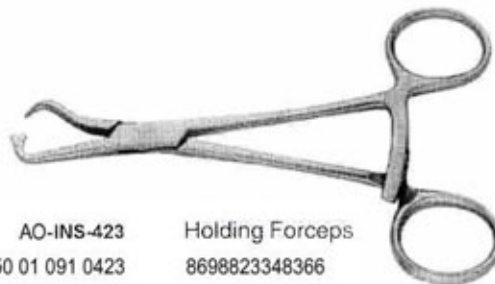

AO-INS-423 Holding Forceps  
 A550 01 091 0423 8698823348366



AO-INS-424 Reduction Forceps with points  
 A550 01 091 0424 8698823348373



AO-INS-425 Hohmann Retractor 6 mm  
 AO-INS-426 Hohmann Retractor 8 mm  
 A550 01 091 0425 8698823348380  
 A550 01 091 0426 8698823348397

### Instruments for 7 mm Cannulated Screws



AO-INS-475      Drill Bit 5.0 mm  $\phi$   
A550 01 091 0475      8698823348403

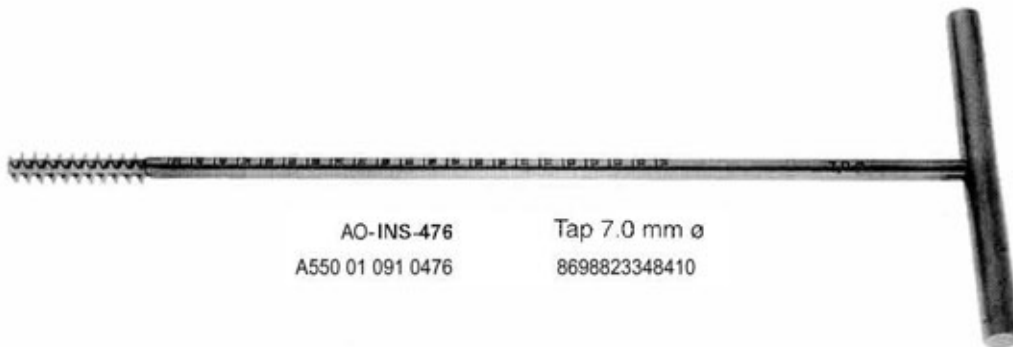

AO-INS-476      Tap 7.0 mm  $\phi$   
A550 01 091 0476      8698823348410



AO-INS-477      5 mm Screw Driver for 7 mm screws  
A550 01 091 0477      8698823348427

**Instruments for Angled Blade Plates**



AO-INS-480  
A550 01 091 0480

Triple Drill Guide with fixed angle 130°  
8698823348434



AO-INS-481  
A550 01 091 0481

Drill Guide round hole plates, long  
8698823348441



AO-INS-482  
A550 01 091 0482

Reamer with end for quick coupling  
8698823348458



AO-INS-483  
A550 01 091 0483

Chisel Guide adjustable angle  
8698823348465



AO-INS-484  
A550 01 091 0484

Inserter Extractor  
8698823348472



AO-INS-485  
A550 01 091 0485

Seating Chisel  
8698823348489



AO-INS-486  
A550 01 091 0486

Slotted Hammer  
8698823348496



AO-INS-487  
A550 01 091 0487

Impactor  
8698823348502



**Instruments for Angled Blade Plates**



**AO-INS-488** Triangular Positioning Plate 80°/70°/30°  
 A550 01 091 0488 8698823348519



**AO-INS-489** Triangular Positioning Plate 90°/50°/40°  
 A550 01 091 0489 8698823348526



**AO-INS-490** Triangular Positioning Plate 100°/60°/20°  
 A550 01 091 0490 8698823348533



**AO-INS-491** Quadrangular Positioning Plate 110°/90°/90°/70°  
 A550 01 091 0491 8698823348540



**AO-INS-492** Condylar Plate Guide  
 A550 01 091 0492 8698823348557



**AO-INS-493** Neutral and Load Hip Drill Guide, long  
 A550 01 091 0493 8698823348564



AO-INS-500 Calibrated Threaded Guide Pin  
o 2.5 mm 230 mm length, 10 mm Thread  
A550 01 091 0500 8698823348571

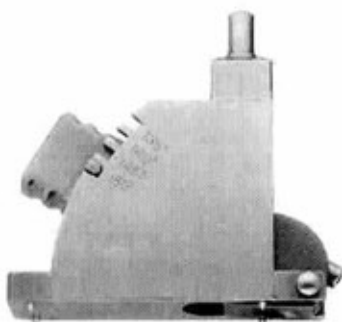

AO-INS-501 Drill Guide adjustable  
to 135°/140°/145°/150°  
A550 01 091 0501 8698823348588



AO-INS-502 Measuring Gauge  
A550 01 091 0502 8698823348595



AO-INS-503 Triple Reamer Complete  
A550 01 091 0503 8698823348601



AO-INS-504 Tap  
A550 01 091 0504 8698823348618



AO-INS-505 Guide Sleeve Short  
A550 01 091 0505 8698823348625



AO-INS-506 Guide Sleeve, long, for screwing in of the lag screws  
A550 01 091 0506 8698823348632



AO-INS-507 Guide Shaft for Insertion of Coupling Screws  
A550 01 091 0507 8698823348649



AO-INS-511 Coupling Screw for Femoral Dynamic Hip Screw



AO-INS-508 Guide Shaft  
A550 01 091 0508 8698823348656

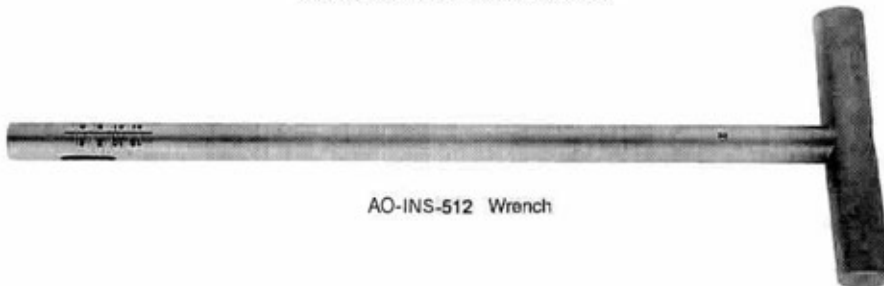

AO-INS-512 Wrench



AO-INS-509 Impactor  
A550 01 091 0509 8698823348663



AO-INS-510 T-Handle  
A550 01 091 0510 8698823348670

## Harrington Instrument Set



**AO-INS-600**  
**Driver straight**  
**for Large Hooks**

A550 01 091 0600  
 8698823348700



**AO-INS-601**  
**Driver curved**  
**for Large Hooks**

A550 01 091 0601  
 8698823348717



**AO-INS-602**  
**Driver straight**  
**for Small Hooks**

A550 01 091 0602  
 8698823348724



**AO-INS-603**  
**Driver curved**  
**for Small Hooks**

A550 01 091 0603  
 8698823348731



**AO-INS-604**  
**Flat wrench**  
**for Sacral Nuts**

A550 01 091 0604  
 8698823348748



**AO-INS-605**  
**Distraction**  
**Rod Clamp**

A550 01 091 0605  
 8698823348755



**AO-INS-606**  
**Hook Clamp**  
**Single Locator**

A550 01 091 0606  
 8698823348762



**AO-INS-607**  
**Hook Clamp**  
**Double Locator**

A550 01 091 0607  
 8698823348779



**AO-INS-608**  
**"C" Ring Clincher**

A550 01 091 0608  
 8698823348786



AO-INS-609  
**"C" Spreader**  
A550 01 091 0609  
8698823348793

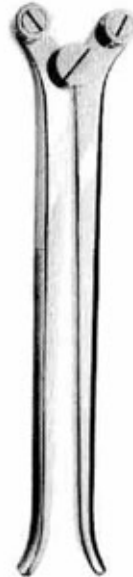

AO-INS-610  
**French Rod Bender**  
A550 01 091 0610  
8698823348809



**Spinal Elevators**

- AO-INS-611 9 mm broad
- AO-INS-612 13 mm broad
- AO-INS-613 16 mm broad
- AO-INS-614 19 mm broad

- A550 01 091 0611 8698823348816
- A550 01 091 0612 8698823348823
- A550 01 091 0613 8698823348830
- A550 01 091 0614 8698823348847



AO-INS-615  
**Small Threaded  
Rod Clamp**  
A550 01 091 0615  
8698823348854



AO-INS-616  
**Large Threaded  
Rod Clamp**  
A550 01 091 0616  
8698823348861



AO-INS-617  
**Outrigger Distraction  
Unit**  
A550 01 091 0617  
8698823348878



**AO-INS-629**  
Bending Pliers for  
2.7 mm and 3.5 mm Plates  
A550 01 091 0629  
8698823348885



**AO-INS-625** Bending Templates  
for curved Reconstruction Plates 4.5 mm  
**AO-INS-626** Bending Templates  
for straight Reconstruction Plates 4.5 mm  
**AO-INS-627** Bending Templates  
for curved Reconstruction Plates 3.5 mm  
**AO-INS-628** Bending Templates  
for straight Reconstruction Plates 3.5 mm

A550 01 091 0625	8698823348892
A550 01 091 0626	8698823348908
A550 01 091 0627	8698823348915
A550 01 091 0628	8698823348922



**AO-INS-630**  
Bending Iron  
for 3.5 mm and 4.5 mm Plates  
A550 01 091 0630  
8698823348939



**AO-INS-631** Osteotomy Chisels 304 mm  
15 mm  
**AO-INS-632** Osteotomy Chisels 304 mm  
20 mm  
A550 01 091 0631 8698823348946  
A550 01 091 0632 8698823348953



AO-INS-633 Tap Handle for Jacobs Chuck  
A550 01 091 0633 8698823348960



AO-INS-634 Sharp Bone Hook  
A550 01 091 0634 8698823348977



AO-INS-635  
long wide tip for Pelvic  
Surgery, width 24 mm  
A550 01 091 0635  
8698823348984



AO-INS-636 Pelvic Reposition Forceps 190 mm  
for Screws 3,5 mm  
AO-INS-637 Pelvic Reposition Forceps 190 mm  
for Screws 4,5 mm  
A550 01 091 0636 8698823348991  
A550 01 091 0637 8698823349004



AO-INS-638  
Reduction Forceps  
with points 200 mm  
A550 01 091 0638  
8698823349011

**Pelvic Instruments**

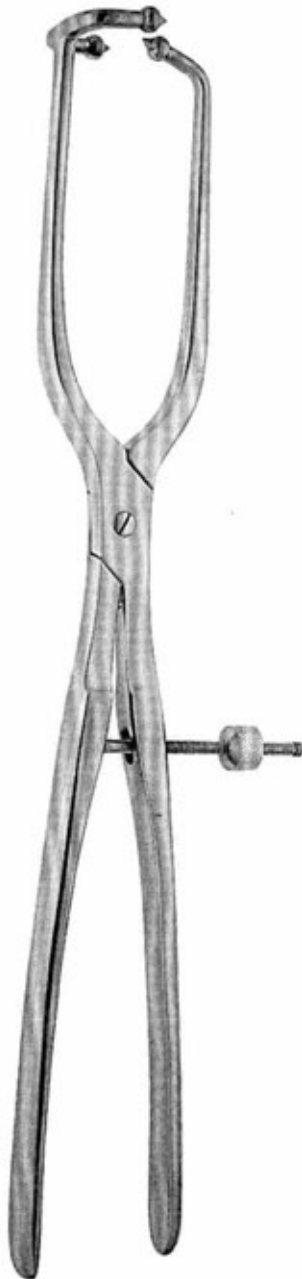

AO-INS-642

Pelvic Reposition Forceps 400 mm

A550 01 091 0642

8698823349028

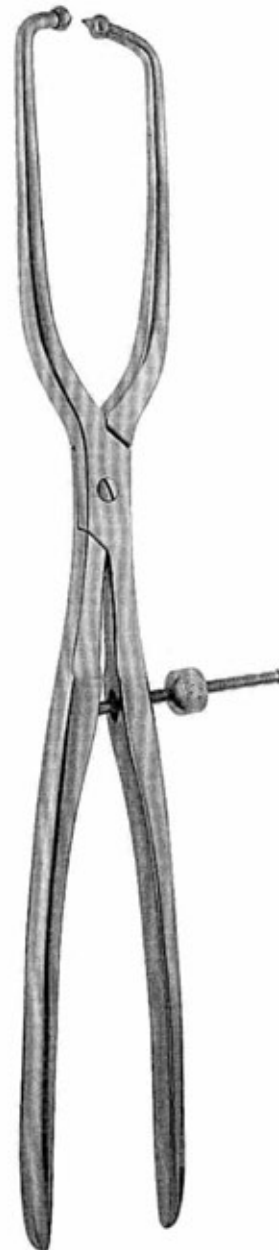

AO-INS-643

Pelvic Reposition Forceps 400 mm

A550 01 091 0643

8698823349035



## Pelvis Reposition Forceps



A550 01 091 0644  
8698823349042

AO-INS-644  
Straight Ball Spike  
12"



AO-INS-645  
Schanze Screws A550 01 091 0645  
ø 6 mm 200 mm 8698823349059

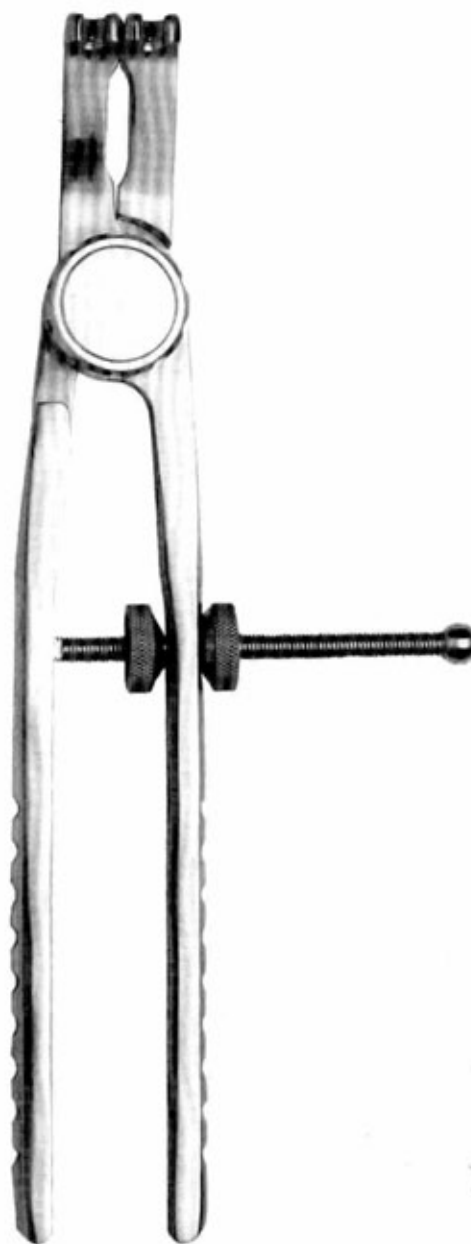

AO-INS-646  
Reposition Forceps A550 01 091 0646  
8698823349066



**AO-INS-700** Kern Baby Bone Holding Forceps 160 mm with ratchet

**AO-INS-701** Kern Baby Bone Holding Forceps 160 mm without ratchet

**AO-INS-702** Kern Bone Holding Forceps 210 mm with ratchet

**AO-INS-703** Kern Bone Holding Forceps 210 mm without ratchet

A550 01 091 0700	8698823349073
A550 01 091 0701	8698823349080
A550 01 091 0702	8698823349097
A550 01 091 0703	8698823349103

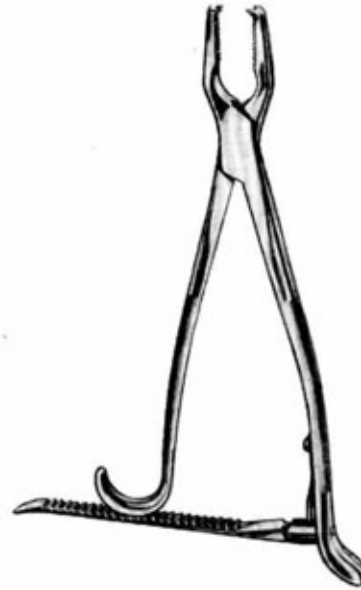

**AO-INS-704** Lane Bone Holding Forceps 330 mm with ratchet

**AO-INS-705** Lane Bone Holding Forceps 330 mm without ratchet

**AO-INS-706** Lane Bone Holding Forceps 450 mm without ratchet

A550 01 091 0704	8698823349110
A550 01 091 0705	8698823349127
A550 01 091 0706	8698823349134



**AO-INS-707** Farabeuf-Lambotte Bone Holding Forceps 260 mm with ratchet

**AO-INS-708** Farabeuf-Lambotte Bone Holding Forceps 260 mm without ratchet

A550 01 091 0707	8698823349141
A550 01 091 0708	8698823349158



**AO-INS-709** Lambotte Bone Holding Forceps 220 mm

**AO-INS-710** Lambotte Bone Holding Forceps 270 mm

**AO-INS-711** Lambotte Bone Holding Forceps 330 mm

A550 01 091 0709	8698823349165
A550 01 091 0710	8698823349172
A550 01 091 0711	8698823349189



AO-INS-712 Verbrügge Bone Holding Forceps 175 mm

A550 01 091 0712 8698823349196

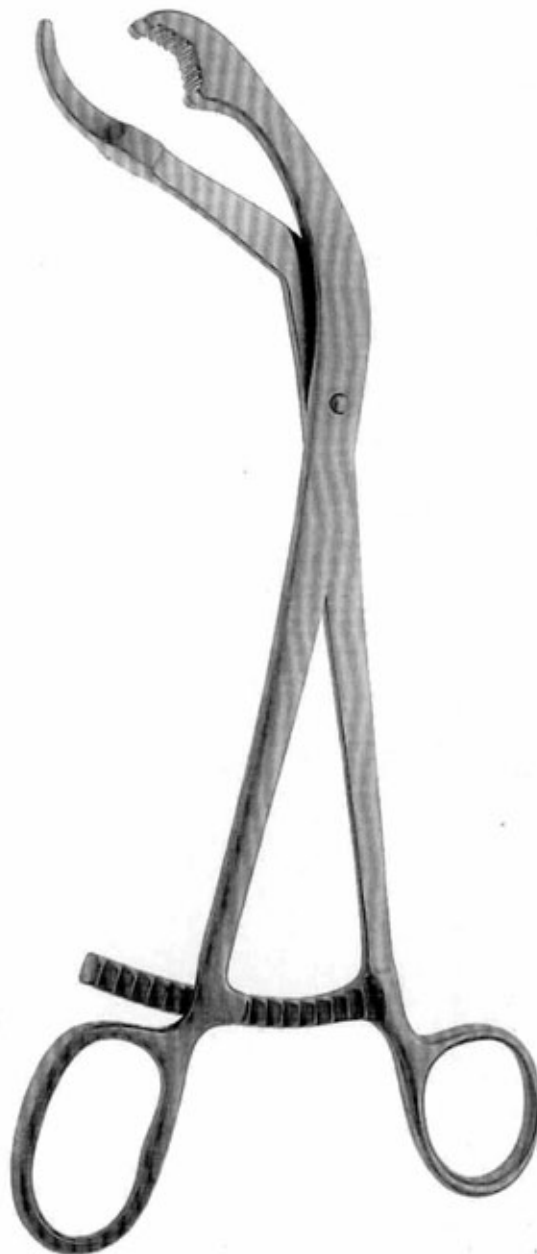

AO-INS-713 Verbrügge Bone Holding Forceps 250 mm

AO-INS-714 Verbrügge Bone Holding Forceps 260 mm

AO-INS-715 Verbrügge Bone Holding Forceps 270 mm

A550 01 091 0713 8698823349202

A550 01 091 0714 8698823349219

A550 01 091 0715 8698823349226



AO-INS-716 Reduction Forceps with Thread Lock 240 mm

A550 01 091 0716

8698823349233



AO-INS-717 Reduction Forceps with Thread Lock 160 mm

A550 01 091 0717

8698823349240



AO-INS-718 Ferguson Bone Holding Forceps 230 mm

A550 01 091 0718

8698823349257



**Self-Centering Bone Holding Forceps with Thread Lock**

AO-INS-719 For Small Fragments 150 mm, jaw 9 mm

AO-INS-720 Size 0  
190 mm, extra small jaw 10 mm

AO-INS-721 Size 1  
240mm, small jaw 14 mm

AO-INS-722 Size 2  
260 mm, medium jaw 18 mm

AO-INS-723 Size 3  
280 mm, large jaw 23 mm

A550 01 091 0719	8698823349264
A550 01 091 0720	8698823349271
A550 01 091 0721	8698823349288
A550 01 091 0722	8698823349295
A550 01 091 0723	8698823349301



AO-INS-724 Lewin 190 mm

A550 01 091 0724 8698823349318



AO-INS-725 Semb 200 mm  
AO-INS-726 Semb 200 mm with ratchet

A550 01 091 0725 8698823349325  
A550 01 091 0726 8698823349332



AO-INS-727 Reposition Forceps  
for Small Fragments 135 mm

A550 01 091 0727 8698823349349



AO-INS-728  
Forceps with Ratchet  
Fixation 145 mm  
A550 01 091 0728  
8698823349356



AO-INS-729  
Reil 170 mm  
A550 01 091 0729  
8698823349363



AO-INS-730  
Reduction Forceps  
with points 200 mm  
A550 01 091 0730  
8698823349370



AO-INS-731 Lowmann Bone Clamp 130 mm  
AO-INS-732 Lowmann Bone Clamp 185 mm  
AO-INS-733 Lowmann Bone Clamp 200 mm

A550 01 091 0731  
A550 01 091 0732  
A550 01 091 0733

8698823349387  
8698823349394  
8698823349400



AO-INS-734 Redposition Forceps 230 mm  
A550 01 091 0734 8698823349417



AO-INS-735 200 mm  
A550 01 091 0735 8698823349424



AO-INS-736 Malleolar Forceps  
A550 01 091 0736 8698823349431



AO-INS-737 For fingers, with Drill  
Guide for Kirschner  
Wires up to  $\varnothing$  1 mm 170 mm

A550 01 091 0737 8698823349448



AO-INS-738 Holding Forceps for Mini 135 mm

A550 01 091 0738 8698823349455





AO-INS-739 Ulrich 230 mm  
 AO-INS-740 Ulrich 250 mm  
 AO-INS-741 Ulrich 280 mm  
 AO-INS-742 Mini 190 mm

A550 01 091 0739 8698823349462  
 A550 01 091 0740 8698823349479  
 A550 01 091 0741 8698823349486  
 A550 01 091 0742 8698823349493



AO-INS-743 Ulrich 260 mm  
 A550 01 091 0743 8698823349509

**Standard Retractors**



AO-INS-744  
 Small, width 6 mm  
 short, narrow tip  
 A550 01 091 0744  
 8698823349516



AO-INS-745  
 Small, width 8 mm  
 short, narrow tip  
 A550 01 091 0745  
 8698823349523



AO-INS-746  
 For Small Fragments  
 with broad shank  
 A550 01 091 0746  
 8698823349530



AO-INS-747  
 Width 8 mm  
 short, narrow tip  
 A550 01 091 0747  
 8698823349547



AO-INS-748 width 18 mm short, narrow tip  
 AO-INS-749 width 18 mm long, narrow tip  
 A550 01 091 0748 8698823349554  
 A550 01 091 0749 8698823349561



AO-INS-750 width 43 mm narrow tip  
 AO-INS-751 width 70 mm narrow tip  
 A550 01 091 0750 8698823349578  
 A550 01 091 0751 8698823349585



AO-INS-752 width 43 mm long shank, angled  
 A550 01 091 0752 8698823349592



AO-INS-753  
width 22 mm  
wide tip

A550 01 091 0753  
8698823349608



AO-INS-754  
long wide tip for Hip  
Surgery, width 24 mm

A550 01 091 0754  
8698823349615

## Bone Hammers

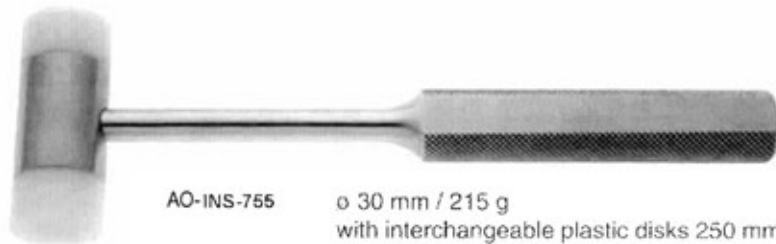

AO-INS-755     $\varnothing$  30 mm / 215 g  
 with interchangeable plastic disks 250 mm  
 A550 01 091 0755    8698823349622



AO-INS-756    Weight approx: 350 g  
 AO-INS-757    Weight approx: 500 g (Standard size)  
 AO-INS-758    Weight approx: 700 g (For Medullary Nailing)

A550 01 091 0756    8698823349639  
 A550 01 091 0757    8698823349646  
 A550 01 091 0758    8698823349653

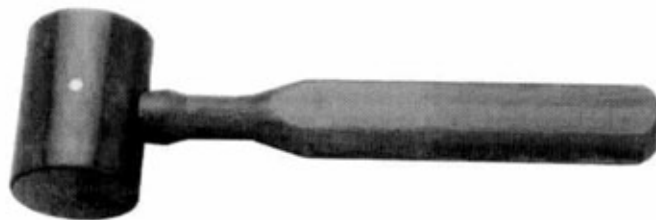

AO-INS-759     $\varnothing$  42 mm, 250 mm  
 Material Ferrozell can be sterilized in an autoclave at 3 bar overpressure (143° C)

A550 01 091 0759  
 8698823349660



AO-INS-760    18,0 cm length,  $\varnothing$  30 mm, 125 g (4 oz)  
 Material Ferrozell can be sterilized in an autoclave at 3 bar overpressure (143° C)

A550 01 091 0760    8698823349677

## Periosteal Elevators

with synthetic handle, autoclavable



AO-INS-761

Medium straight blade  
round edge, width 14 mm

A550 01 091 0761  
8698823349684



AO-INS-762

medium curved blade  
round edge, width 14 mm

A550 01 091 0762  
8698823349691



AO-INS-763

large straight blade  
round edge, width 30 mm

A550 01 091 0763  
8698823349707



AO-INS-764

Small curved blade  
round edge, width 6 mm

A550 01 091 0764  
8698823349714



AO-INS-765

Small curved blade  
straight edge, width 6 mm

A550 01 091 0765  
8698823349721



AO-INS-766

Extra small curved blade  
straight edge, width 3 mm

A550 01 091 0766  
8698823349738



A550 01 091 0767 8698823349745  
 A550 01 091 0768 8698823349752  
 A550 01 091 0769 8698823349769  
 A550 01 091 0770 8698823349776



AO-INS-767 Chisel Blade 10 mm  
 AO-INS-768 Chisel Blade 16 mm  
 AO-INS-769 Chisel Blade 25 mm  
 AO-INS-770 Chisel Blade 5 mm



AO-INS-772 Wrench for Chisel Handle  
 A550 01 091 0772 8698823349790



A550 01 091 0773 8698823349806  
 A550 01 091 0774 8698823349813  
 A550 01 091 0775 8698823349820

AO-INS-771 Chisel Handle  
 A550 01 091 0771 8698823349783

Mini-Lambotte  
 AO-INS-773 170 mm length 2 mm width  
 AO-INS-774 170 mm length 5 mm width  
 AO-INS-775 170 mm length 10 mm width



AO-INS-776 straight 5 mm  
 AO-INS-777 10 mm  
 AO-INS-778 15 mm  
 A550 01 091 0776 8698823349837  
 A550 01 091 0777 8698823349844  
 A550 01 091 0778 8698823349851

AO-INS-779 curved 5 mm  
 AO-INS-780 10 mm  
 AO-INS-781 15 mm  
 A550 01 091 0779 8698823349868  
 A550 01 091 0780 8698823349875  
 A550 01 091 0781 8698823349882

AO-INS-782 flat 10 mm  
 AO-INS-783 15 mm  
 AO-INS-784 20 mm  
 AO-INS-785 25 mm  
 A550 01 091 0782 8698823349899  
 A550 01 091 0783 8698823349905  
 A550 01 091 0784 8698823349912  
 A550 01 091 0785 8698823349929

AO-INS-786 hollow 10 mm  
 AO-INS-787 15 mm  
 AO-INS-788 20 mm  
 AO-INS-789 25 mm  
 A550 01 091 0786 8698823349936  
 A550 01 091 0787 8698823349943  
 A550 01 091 0788 8698823349950  
 A550 01 091 0789 8698823349967

#### Bone Surgery Bone Chisel and Gouges



AO-INS-790	Smith Peterson	6 mm
AO-INS-791	Smith Peterson	9 mm
AO-INS-792	Smith Peterson	12 mm
AO-INS-793	Smith Peterson	15 mm
AO-INS-794	Smith Peterson	20 mm
AO-INS-795	Smith Peterson	25 mm
AO-INS-796	Smith Peterson	30 mm
A550 01 091 0790	8698823349974	
A550 01 091 0791	8698823349981	
A550 01 091 0792	8698823349998	
A550 01 091 0793	8698823350000	
A550 01 091 0794	8698823350017	
A550 01 091 0795	8698823350024	
A550 01 091 0796	8698823350031	



AO-INS-797	Smith Peterson curved	6 mm
AO-INS-798	Smith Peterson curved	9 mm
AO-INS-799	Smith Peterson curved	12 mm
AO-INS-800	Smith Peterson curved	15 mm
AO-INS-801	Smith Peterson curved	20 mm
AO-INS-802	Smith Peterson curved	25 mm
AO-INS-803	Smith Peterson curved	30 mm
A550 01 091 0797	8698823350048	
A550 01 091 0798	8698823350055	
A550 01 091 0799	8698823350062	
A550 01 091 0800	8698823350079	
A550 01 091 0801	8698823350086	
A550 01 091 0802	8698823350093	
A550 01 091 0803	8698823350109	



AO-INS-804	Smith Peterson Gouge	6 mm
AO-INS-805	Smith Peterson Gouge	9 mm
AO-INS-806	Smith Peterson Gouge	12 mm
AO-INS-807	Smith Peterson Gouge	15 mm
AO-INS-808	Smith Peterson Gouge	20 mm
AO-INS-809	Smith Peterson Gouge	25 mm
AO-INS-810	Smith Peterson Gouge	30 mm

A550 01 091 0804	8698823350116
A550 01 091 0805	8698823350123
A550 01 091 0806	8698823350130
A550 01 091 0807	8698823350147
A550 01 091 0808	8698823350154
A550 01 091 0809	8698823350161



AO-INS-811	Smith Peterson curved Gouge	6 mm
AO-INS-812	Smith Peterson curved Gouge	9 mm
AO-INS-813	Smith Peterson curved Gouge	12 mm
AO-INS-814	Smith Peterson curved Gouge	15 mm
AO-INS-815	Smith Peterson curved Gouge	20 mm
AO-INS-816	Smith Peterson curved Gouge	25 mm
AO-INS-817	Smith Peterson curved Gouge	30 mm

A550 01 091 0811	8698823350185
A550 01 091 0812	8698823350192
A550 01 091 0813	8698823350208
A550 01 091 0814	8698823350215
A550 01 091 0815	8698823350222
A550 01 091 0816	8698823350239
A550 01 091 0817	8698823350246



AO-INS-818	Stille 10 mm
AO-INS-819	Stille 12 mm
AO-INS-820	Stille 15 mm
AO-INS-821	Stille 20 mm
AO-INS-822	Stille 25 mm

A550 01 091 0818	8698823350253
A550 01 091 0819	8698823350260
A550 01 091 0820	8698823350277
A550 01 091 0821	8698823350284
A550 01 091 0822	8698823350291



AO-INS-823	Stille Gouge 10 mm
AO-INS-824	Stille Gouge 12 mm
AO-INS-825	Stille Gouge 15 mm
AO-INS-826	Stille Gouge 20 mm
AO-INS-827	Stille Gouge 25 mm

A550 01 091 0823	8698823350307
A550 01 091 0824	8698823350314
A550 01 091 0825	8698823350321
A550 01 091 0826	8698823350338
A550 01 091 0827	8698823350345



AO-INS-828	Lambotte 10 mm
AO-INS-829	Lambotte 12 mm
AO-INS-830	Lambotte 15 mm
AO-INS-831	Lambotte 20 mm
AO-INS-832	Lambotte 25 mm
AO-INS-833	Lambotte 30 mm
AO-INS-834	Lambotte 38 mm
AO-INS-835	Lambotte 44 mm
AO-INS-836	Lambotte 50 mm

A550 01 091 0828	8698823350352
A550 01 091 0829	8698823350369
A550 01 091 0830	8698823350376
A550 01 091 0831	8698823350383
A550 01 091 0832	8698823350390
A550 01 091 0833	8698823350406
A550 01 091 0834	8698823350413
A550 01 091 0835	8698823350420
A550 01 091 0836	8698823350437



AO-INS-837	Lambotte curved 10 mm
AO-INS-838	Lambotte curved 12 mm
AO-INS-839	Lambotte curved 15 mm
AO-INS-840	Lambotte curved 20 mm
AO-INS-841	Lambotte curved 25 mm
AO-INS-842	Lambotte curved 30 mm
AO-INS-843	Lambotte curved 38 mm
AO-INS-844	Lambotte curved 44 mm
AO-INS-845	Lambotte curved 50 mm

A550 01 091 0837	8698823350444
A550 01 091 0838	8698823350451
A550 01 091 0839	8698823350468
A550 01 091 0840	8698823350475
A550 01 091 0841	8698823350482
A550 01 091 0842	8698823350499
A550 01 091 0843	8698823350505
A550 01 091 0844	8698823350512
A550 01 091 0845	8698823350529



**Chisels, Periosteal Raspatories**



AO-INS-846  
 Mini Lexer 18 cm  
 A550 01 091 0846  
 8698823350536



AO-INS-847  
 Mini Lexer 18 cm  
 A550 01 091 0847  
 8698823350543



AO-INS-848  
 Langenbeck 18 cm  
 A550 01 091 0848  
 8698823350550



AO-INS-849  
 Langenbeck 19 cm  
 A550 01 091 0849  
 8698823350567



AO-INS-850  
 Farabeuf  
 A550 01 091 0850  
 8698823350574



AO-INS-851  
 Farabeuf  
 A550 01 091 0851  
 8698823350581



AO-INS-852 5 mm  
 AO-INS-853 6 mm  
 AO-INS-854 7 mm  
 A550 01 091 0852 8698823350598  
 A550 01 091 0853 8698823350604  
 A550 01 091 0854 8698823350611

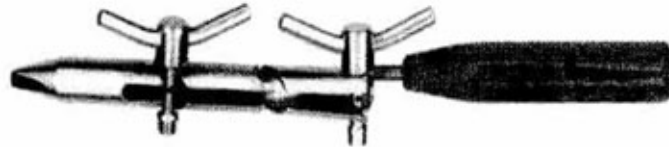

AO-INS-855 Wire Tightener

A550 01 091 0855

8698823350628



AO-INS-856 Bending Iron  
for Kirschner Wires<sup>®</sup>  
A550 01 091 0856  
8698823350635



AO-INS-857 Pliers with serrated  
jaws and groove  
A550 01 091 0857  
8698823350642



AO-INS-859 Rounded Pliers with  
serrated jaws  
A550 01 091 0859  
8698823350666

AO-INS-858 Pliers with serrated  
jaws without groove  
A550 01 091 0858  
8698823350659



AO-INS-860 Loute 22 cm Bone Wire Tightener  
A550 01 091 0860 8698823350673

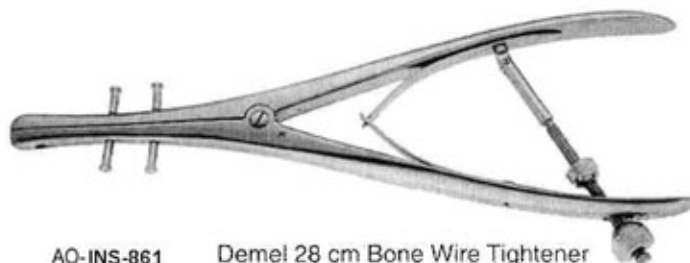

AO-INS-861 Demel 28 cm Bone Wire Tightener  
A550 01 091 0861 8698823350680

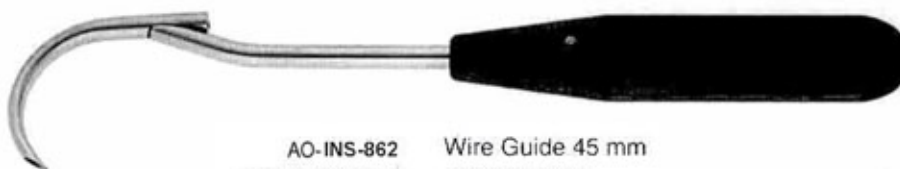

AO-INS-862 Wire Guide 45 mm  
A550 01 091 0862 8698823350697

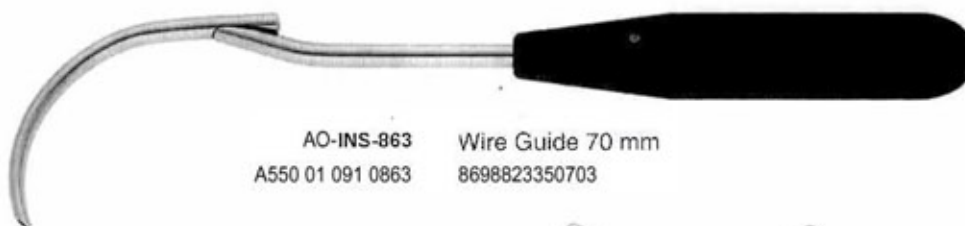

AO-INS-863 Wire Guide 70 mm  
A550 01 091 0863 8698823350703

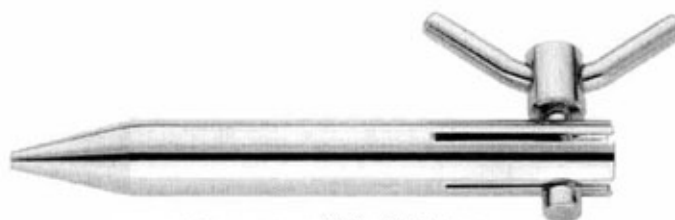

AO-INS-864 Wire Tightener  
A550 01 091 0864 8698823350710



AO-INS-865 Extraction Pliers for boring wire 130 mm  
A550 01 091 0865 8698823350727

AO-INS-866 Extraction Pliers for boring wire 180 mm  
A550 01 091 0866 8698823350734



AO-INS-867 Extraction Pliers for wire 180 mm  
A550 01 091 0867 8698823350741

AO-INS-868 Extraction Pliers TC jaws  
A550 01 091 0868 8698823350758



AO-INS-869 Vise Grip 180 mm Chrom Vanadium  
A550 01 091 0869 8698823350765

AO-INS-870 Vise Grip 180 mm Stainless Steel  
A550 01 091 0870 8698823350772

AO-INS-871 Vise Grip 200 mm Stainless Steel  
A550 01 091 0871 8698823350789

AO-INS-872 Vise Grip 240 mm Stainless Steel  
A550 01 091 0872 8698823350796



AO-INS-873 Flat-nosed Pliers, parallel,  
with lateral Wire Cutter, 180 mm  
A550 01 091 0873 8698823350802  
Chrom Vanadium Steel

AO-INS-874 Flat-nosed Pliers, parallel,  
without lateral Wire Cutter, 180 mm  
A550 01 091 0874 8698823350819  
Chrom Vanadium Steel

AO-INS-875 Flat-nosed Pliers, parallel,  
without lateral Wire Cutter, 180 mm  
A550 01 091 0875 8698823350826  
Stainless Steel

AO-INS-876 Flat-nosed Pliers, parallel,  
with lateral Wire Cutter, 180 mm  
A550 01 091 0876 8698823350833  
Stainless Steel

## Extraction Instruments



AO-INS-877 Extraction Pliers, 190 mm TC  
A550 01 091 0877 8698823350840



AO-INS-878 Extraction Pliers, 200 mm TC  
A550 01 091 0878 8698823350857

### Wire Cutters



AO-INS-879 TC 180 mm  
soft wire 2.0 mm  
hard wire 1.5 mm  
A550 01 091 0879 8698823350864

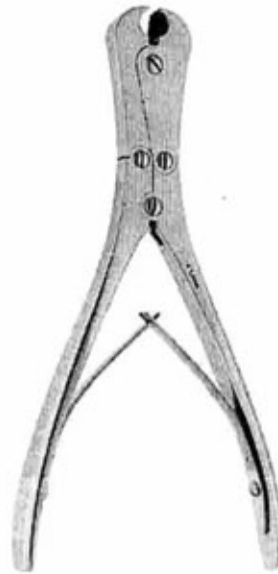

AO-INS-880 180 mm frontal and lateral  
cutting action TC  
soft wire 2.0 mm  
hard wire 1.5 mm  
A550 01 091 0880 8698823350871

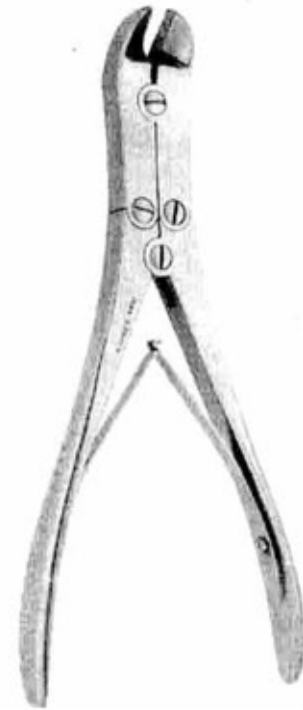

AO-INS-881 Wire Cutter 220 mm TC  
soft wire 3.0 mm  
hard wire 2.5 mm  
A550 01 091 0881 8698823350888



AO-INS-882 Wire Cutter 220 mm TC  
soft wire 2.5 mm  
hard wire 2.2 mm  
A550 01 091 0882 8698823350895



AO-INS-883 Wire Cutter TC 140 mm  
soft wire 1.2 mm  
hard wire 0.8 mm  
A550 01 091 0883 8698823350901



AO-INS-884 Wire Cutter TC  
soft wire 3.0 mm  
hard wire 2.5 mm  
A550 01 091 0884 8698823350918

**Wire Cutters**

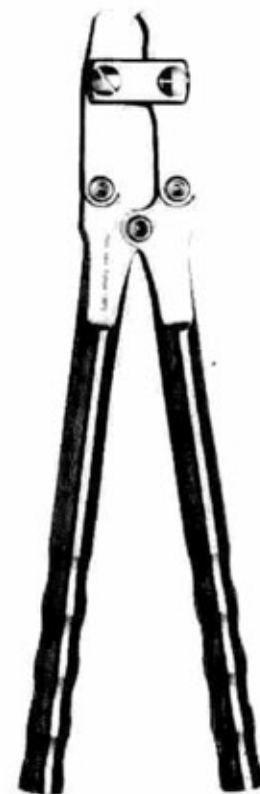

**AO-INS-885** Cutter for cutting of Kirschner wires  
 Steinmann Pins up to 6 mm ø hard  
 540 mm TC

**AO-INS-886** Cutter for cutting of Kirschner wires  
 Steinmann Pins up to 6 mm ø hard  
 460 mm TC

A550 01 091 0885 8698823350925  
 A550 01 091 0886 8698823350932

**AO-INS-887** 575 mm  
 Hard wire 6.0 mm\*

A550 01 091 0887 8698823350949

**AO-INS-888** 260 mm  
 Hard wire 3.5 mm

A550 01 091 0888 8698823350956



#### Bone Cutting Forceps



Liston Bone Cutting Forceps		AO-INS-898	Ruskin-Liston 190 mm straight	AO-INS-900	Stille-Liston 270 mm straight
AO-INS-889	140 mm straight	AO-INS-899	Ruskin-Liston 190 mm curved	AO-INS-901	Stille-Liston 270 mm curved
AO-INS-890	140 mm curved	A550 01 091 0889	8698823350963	A550 01 091 0896	8698823351038
AO-INS-891	170 mm straight	A550 01 091 0890	8698823350970	A550 01 091 0898	8698823351045
AO-INS-892	170 mm curved	A550 01 091 0891	8698823350987	A550 01 091 0899	8698823351052
AO-INS-893	190 mm straight	A550 01 091 0892	8698823350994	A550 01 091 0900	8698823351069
AO-INS-894	190 mm curved	A550 01 091 0893	8698823351007	A550 01 091 0901	8698823351076
AO-INS-895	220 mm straight	A550 01 091 0894	8698823351014		
AO-INS-896	220 mm curved	A550 01 091 0895	8698823351021		
AO-INS-897					



AO-INS-902	Stille Horsley 270 mm	AO-INS-903	Stille Semb 270 mm	AO-INS-904	Böhler 150 mm straight
A550 01 091 0902	8698823351083	A550 01 091 0903	8698823351090	AO-INS-905	Böhler 150 mm curved
				A550 01 091 0904	8698823351106
				A550 01 091 0905	8698823351113

**Bone Rongeur Forceps**



AO-INS-916 Stille Ruskin 240 mm curved  
 A550 01 091 0916 8698823351229



AO-INS-917 Zaufal Jansen 190 mm curved  
 A550 01 091 0917 8698823351236



AO-INS-918 Böhler Rongeur 150 mm straight  
 AO-INS-919 Böhler Rongeur 150 mm curved  
 A550 01 091 0918 8698823351243  
 A550 01 091 0919 8698823351250



AO-INS-920 Beyer Rongeur, curved  
 A550 01 091 0920 8698823351267

**Bone Rongeur Forceps**



AO-INS-916 Stille Ruskin 240 mm curved  
A550 01 091 0916 8698823351229



AO-INS-917 Zaufal Jansen 190 mm curved  
A550 01 091 0917 8698823351236



AO-INS-918 Böhler Rongeur 150 mm straight  
AO-INS-919 Böhler Rongeur 150 mm curved  
A550 01 091 0918 8698823351243  
A550 01 091 0919 8698823351250



AO-INS-920 Beyer Rongeur, curved  
A550 01 091 0920 8698823351267

**Bone Rongeur Forceps**



AO-INS-921	Luer 170 mm straight	A550 01 091 0921	8698823351274
AO-INS-922	Luer 170 mm curved	A550 01 091 0922	8698823351281



AO-INS-923	Lempert 190 mm straight	A550 01 091 0923	8698823351298
AO-INS-924	Lempert 190 mm curved	A550 01 091 0924	8698823351304



AO-INS-925	Lempert 160 mm straight	A550 01 091 0925	8698823351311
AO-INS-926	Lempert 160 mm curved	A550 01 091 0926	8698823351328

### Plaster Instruments



AO-INS-927 Engel  
A550 01 091 0927  
8698823351335



Stille  
AO-INS-928 26 cm  
AO-INS-929 37 mm  
A550 01 091 0928 8698823351342  
A550 01 091 0929 8698823351359



AO-INS-930  
Esmarch  
18,0 cm  
A550 01 091 0930  
8698823351366



AO-INS-931 Mod. Seulin  
21,0 cm  
A550 01 091 0931  
8698823351373



AO-INS-933  
Bruns  
serrated  
A550 01 091 0933  
8698823351397  
AO-INS-932 Bruns  
A550 01 091 0932  
8698823351380

### Plaster Instruments



AO-INS-934  
Hennig  
A550 01 091 0934  
8698823351403



AO-INS-935  
Stryker  
A550 01 091 0935  
8698823351410



Wolff - Böhler  
AO-INS-936 18,0 cm  
AO-INS-937 24,0 cm  
A550 01 091 0936 8698823351427  
A550 01 091 0937 8698823351434



AO-INS-938 Stille Miniatur  
20,0 cm  
A550 01 091 0938  
8698823351441



AO-INS-939 Wolff-Böhler Miniatur  
A550 01 091 0939 8698823351458

Plaster Instruments

for fingers

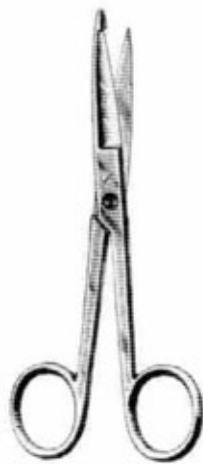

AO-INS-940 A550 01 091 0940  
Knowles 8698823351465  
14,0 cm

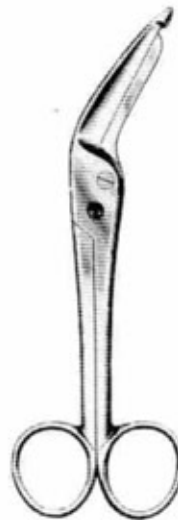

AO-INS-941 A550 01 091 0941  
Lister 8698823351472  
Exentric 19,0 cm

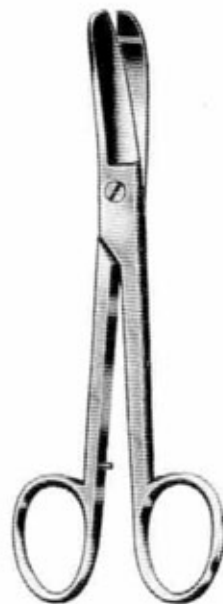

AO-INS-942 A550 01 091 0942  
Lorenz 8698823351489  
23,0cm

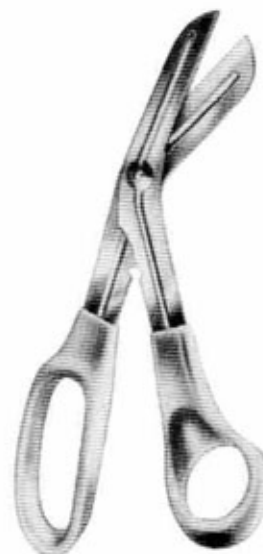

AO-INS-943 A550 01 091 0943  
20,0 cm 8698823351496

### Plaster Instruments

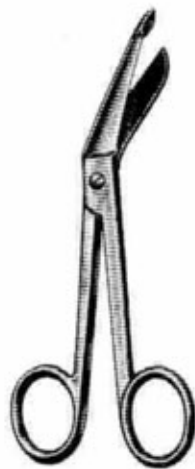

Lister

AO-INS-944	14,0 cm	A550 01 091 0944	8698823351502
AO-INS-945	18,0 cm	A550 01 091 0945	8698823351519
AO-INS-946	20,0 cm	A550 01 091 0946	8698823351526



AO-INS-947

Bergmann	23,0 cm
A550 01 091 0947	8698823351533

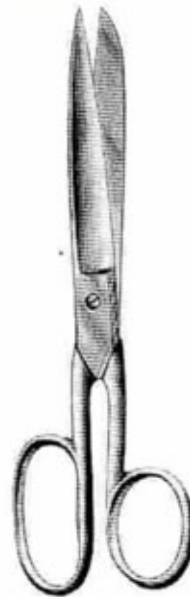

Smith Mod USA

A550 01 091 0948	8698823351540	AO-INS-948	18,0 cm
A550 01 091 0949	8698823351557	AO-INS-949	20,0 cm
A550 01 091 0950	8698823351564	AO-INS-950	23,0 cm



### Neuro Surgery

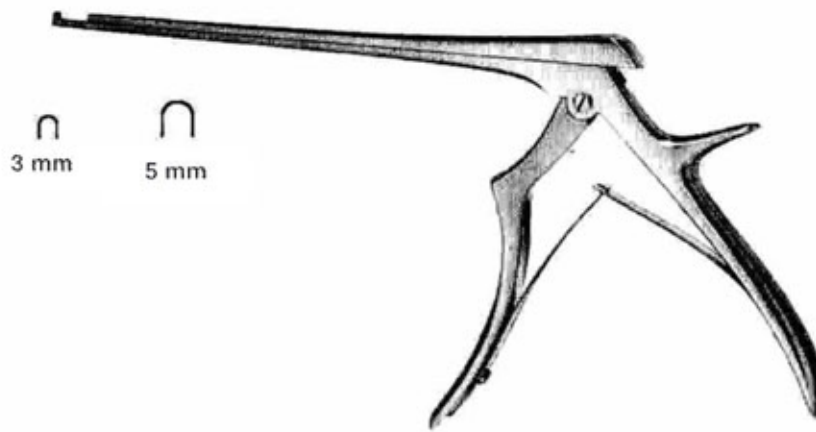

Cervical Rongeur

Cervical Rongeur

Micro - Kerrison

90°

up - cutting

Shaft 200 mm

Bite 3 mm	AO-INS-951
Bite 5 mm	AO-INS-952
A550 01 091 0951	8698823351571
A550 01 091 0952	8698823351588



90°

down - cutting

Shaft 200 mm

Bite 3 mm	AO-INS-955
Bite 5 mm	AO-INS-956
A550 01 091 0955	8698823351595
A550 01 091 0956	8698823351601



40°

up - cutting

Shaft 200 mm

Bite 3 mm	AO-INS-959
Bite 5 mm	AO-INS-960
A550 01 091 0959	8698823351618
A550 01 091 0960	8698823351625

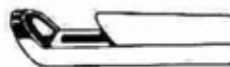

90°

up - cutting

Shaft 180 mm

Bite 1 mm	AO-INS-953
Bite 2 mm	AO-INS-954
A550 01 091 0953	8698823351632
A550 01 091 0954	8698823351649

90°

down - cutting

Shaft 180 mm

Bite 1 mm	AO-INS-957
Bite 2 mm	AO-INS-958
A550 01 091 0957	8698823351656
A550 01 091 0958	8698823351663

40°

up - cutting

Shaft 180 mm

Bite 1 mm	AO-INS-961
Bite 2 mm	AO-INS-962
A550 01 091 0961	8698823351670
A550 01 091 0962	8698823351687

#### Neuro Surgery

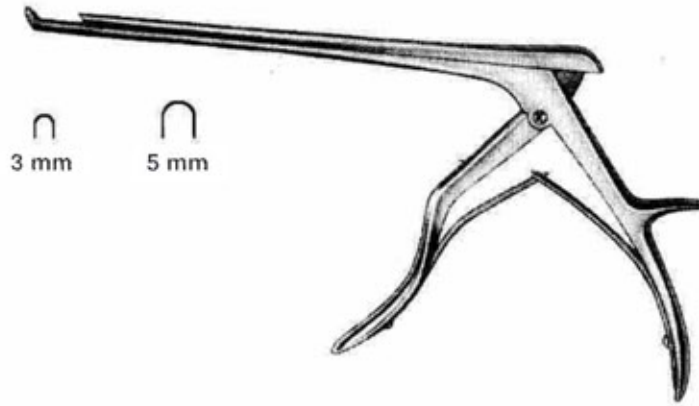

Kerrison

40°

up - cutting



Shaft 200 mm

Bite 3 mm	SE-INS-963
Bite 5 mm	SE-INS-964
A550 01 091 0963	8698823351694
A550 01 091 0964	8698823351700

90°

up - cutting



Shaft 200 mm

Bite 3 mm	SE-INS-965
Bite 5 mm	SE-INS-966
A550 01 091 0965	8698823351717
A550 01 091 0966	8698823351724

90°

down - cutting

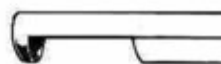

Shaft 200 mm

Bite 3 mm	SE-INS-967
Bite 5 mm	SE-INS-968
A550 01 091 0967	8698823351731
A550 01 091 0968	8698823351748

#### Neuro Surgery

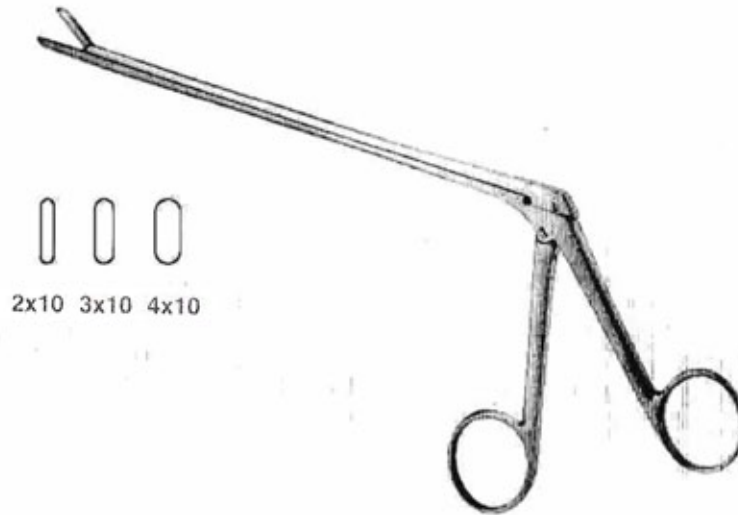

2x10 3x10 4x10

gerade straight

Cushing Love

Shaft 130 mm 180 mm 200 mm

Bite 2x10 mm AO-INS-969 AO-INS-972 AO-INS-975

Bite 3x10 mm AO-INS-970 AO-INS-973 AO-INS-976

Bite 4x10 mm AO-INS-971 AO-INS-974 AO-INS-977



A550 01 091 0969	8698823351755	A550 01 091 0972	8698823351786	A550 01 091 0975	8698823351816
A550 01 091 0970	8698823351762	A550 01 091 0973	8698823351793	A550 01 091 0976	8698823351823
A550 01 091 0971	8698823351779	A550 01 091 0974	8698823351809	A550 01 091 0977	8698823351830

angled - up

Shaft 130 mm 180 mm 200 mm

Bite 2x10 mm AO-INS-978 AO-INS-981 AO-INS-984

Bite 3x10 mm AO-INS-979 AO-INS-982 AO-INS-985

Bite 4x10 mm AO-INS-980 AO-INS-983 AO-INS-986



A550 01 091 0978	8698823351847	A550 01 091 0981	8698823351878	A550 01 091 0984	8698823351908
A550 01 091 0979	8698823351854	A550 01 091 0982	8698823351885	A550 01 091 0985	8698823351915
A550 01 091 0980	8698823351861	A550 01 091 0983	8698823351892	A550 01 091 0986	8698823351922

angled - down

Shaft 130 mm 180 mm 200 mm

Bite 2x10 mm SE-INS-987 SE-INS-990 SE-INS-993

Bite 3x10 mm SE-INS-988 SE-INS-991 SE-INS-994

Bite 4x10 mm SE-INS-989 SE-INS-992 SE-INS-995



A550 01 091 0987	8698823351939	A550 01 091 0990	8698823351960	A550 01 091 0993	8698823351991
A550 01 091 0988	8698823351946	A550 01 091 0991	8698823351977	A550 01 091 0994	8698823352004
A550 01 091 0989	8698823351953	A550 01 091 0992	8698823351984	A550 01 091 0995	8698823352011

## Neuro Surgery

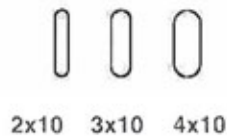
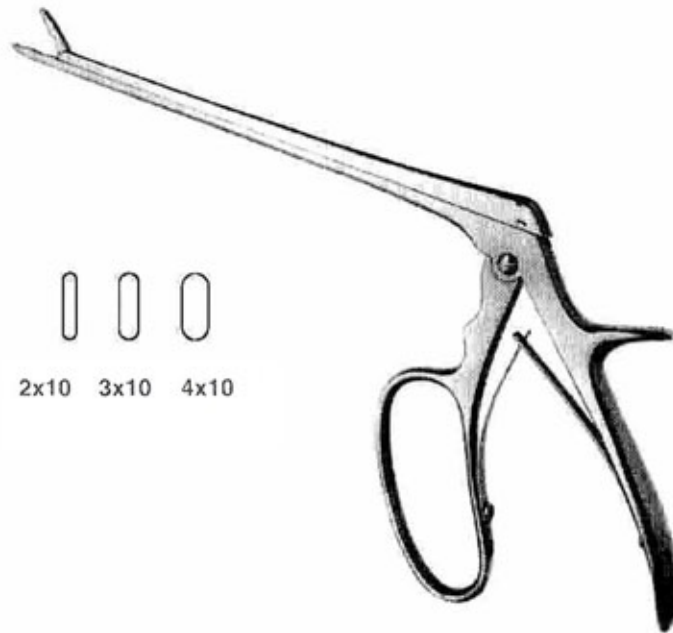

### Ferris - Smith

#### straight



Shaft 180 mm

Bite 2x10 mm AO-INS-996

Bite 3x10 mm AO-INS-997

Bite 4x10 mm AO-INS-998

A550 01 091 0996 8698823352028

A550 01 091 0997 8698823352035

A550 01 091 0998 8698823352042

#### angled - up



Shaft 180 mm

Bite 2x10 mm AO-INS-999

Bite 3x10 mm AO-INS-1000

Bite 4x10 mm AO-INS-1001

A550 01 091 0999 8698823352059

A550 01 091 1000 8698823352066

A550 01 091 1001 8698823352073

#### angled - down



Shaft 180 mm

Bite 2x10 mm AO-INS-1002

Bite 3x10 mm AO-INS-1003

Bite 4x10 mm AO-INS-1004

A550 01 091 1002 8698823352080

A550 01 091 1003 8698823352097

A550 01 091 1004 8698823352103

### Neuro Surgery



AO-INS-1005  
16,0 cm  
Limna small pattern  
A550 01 091 1005 8698823352110



AO-INS-1006  
26,0 cm  
Limna large pattern  
A550 01 091 1006 8698823352127



Cloward  
AO-INS-1007  
13,0 cm  
A550 01 091 1007 8698823352134



Gelpi  
AO-INS-1008 14,0 cm  
AO-INS-1009 17,0 cm  
A550 01 091 1008 8698823352141  
A550 01 091 1009 8698823352158



Beckmann  
AO-INS-1010 16,5 cm sharp  
3x4 prongs, 16 mm deep  
A550 01 091 1010 8698823352165



Beckmann  
AO-INS-1011 16,5 cm sharp  
3x4 prongs, 13 mm deep  
A550 01 091 1011 8698823352172

#### Neuro Surgery



Beckmann

AO-INS-1012 sharp, 24,0 cm  
AO-INS-1013 blunt, 24,0 cm

3x3 prongs, 25 mm deep  
A550 01 091 1012 8698823352189  
A550 01 091 1013 8698823352196



Adson

AO-INS-1014 sharp, 26,5 cm  
AO-INS-1015 blunt, 26,5 cm

5x6 prongs, 35 mm deep  
A550 01 091 1014 8698823352202  
A550 01 091 1015 8698823352219



Beckmann - Adson  
AO-INS-1016  
sharp, 31,0 cm

4x4 prongs, 25 mm deep  
A550 01 091 1016  
8698823352226

Beckmann - Adson  
AO-INS-1017  
sharp, 31,0 cm

4x4 prongs, 44 mm deep  
A550 01 091 1017  
8698823352233



Beckmann - Eaton  
AO-INS-1018  
sharp, 32,0 cm

7x7 prongs, 50 mm deep  
A550 01 091 1018 8698823352240

## Neuro Surgery

### Retractors, Cervical Retractors



Cloward  
AO-INS-1019 17,0 cm

Frame only  
A550 01 091 1019  
8698823352264



Cloward  
AO-INS-1020 17,0 cm

complete with 5 blades  
A550 01 091 1020 8698823352257

#### Cloward

##### Blades only

AO-INS-1021	40 mm
AO-INS-1022	45 mm
AO-INS-1023	50 mm
AO-INS-1024	55 mm
AO-INS-1025	60 mm
A550 01 091 1021	8698823352271
A550 01 091 1022	8698823352288
A550 01 091 1023	8698823352295
A550 01 091 1024	8698823352301
A550 01 091 1025	8698823352318



Cloward  
AO-INS-1026 17,0 cm

Frame only  
A550 01 091 1026 8698823352332

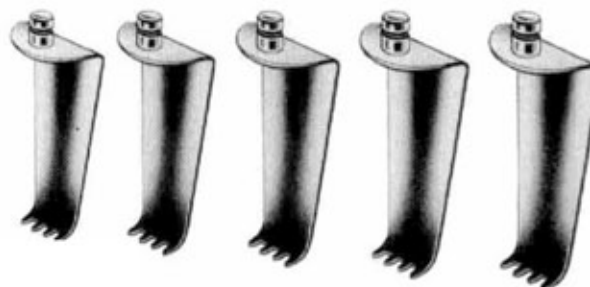

#### Cloward

##### Blades toothed

Cloward  
AO-INS-1027 17,0 cm

complete with 5 blades  
A550 01 091 1027 8698823352325

AO-INS-1028	40 mm
AO-INS-1029	45 mm
AO-INS-1030	50 mm
AO-INS-1031	55 mm
AO-INS-1032	60 mm
A550 01 091 1028	8698823352349
A550 01 091 1029	8698823352356
A550 01 091 1030	8698823352363
A550 01 091 1031	8698823352370
A550 01 091 1032	8698823352387

#### Neuro Surgery



Meyerding

AO-INS-1034 16x50 mm, 20,0 cm  
 AO-INS-1035 25x75 mm, 23,0 cm  
 AO-INS-1036 50x90 mm, 24,0 cm  
 A550 01 091 1034 8698823352394  
 A550 01 091 1035 8698823352400  
 A550 01 091 1036 8698823352417

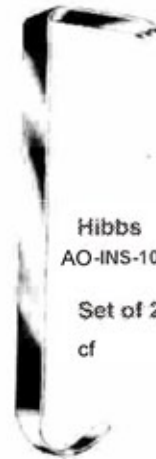

Hibbs  
 AO-INS-1033  
 Set of 2  
 cf

Hibbs

AO-INS-1037 25x75 mm, 23,0 cm  
 AO-INS-1038 25x80 mm, 24,0 cm  
 A550 01 091 1037 8698823352424  
 A550 01 091 1038 8698823352431



fig. 1 + 2

Taylor

AO-INS-1039 30x 75 mm, 17,0 cm  
 AO-INS-1040 30x100 mm, 17,0 cm  
 A550 01 091 1039 8698823352448  
 A550 01 091 1040 8698823352455



Love

AO-INS-1041  
 6 mm, 19,0 cm  
 straight  
 A550 01 091 1041 8698823352462



Love

AO-INS-1042  
 6 mm, 19,0 cm  
 45°  
 A550 01 091 1042 8698823352479



Love

AO-INS-1043  
 6 mm, 19,0 cm  
 90°  
 A550 01 091 1043 8698823352486



Scoville

AO-INS-1044  
 30,0 cm



Scoville

AO-INS-1045  
 30,0 cm

Nerve Hook and Disector

A550 01 091 1044 8698823352493  
 A550 01 091 1045 8698823352509



**Neuro Surgery**



**Pennfield**  
 AO-INS-1046  
 A550 01 091 1046  
 8698823352516



**Davis**  
 AO-INS-1047  
 4 mm, 24,5 cm  
 A550 01 091 1047  
 8698823352523



AO-INS-1048  
 narrow  
 A550 01 091 1048  
 8698823352530

AO-INS-1049  
 wide  
 A550 01 091 1049  
 8698823352547

**Toennis**  
 24,0 cm



**Frazier**  
 AO-INS-1050  
 15,0 cm  
 A550 01 091 1050  
 8698823352554



**Hoen**  
 AO-INS-1051  
 15,0 cm  
 45°  
 A550 01 091 1051  
 8698823352561



**Hoen**  
 AO-INS-1052  
 15,0 cm  
 90°  
 A550 01 091 1052  
 8698823352578

#### Neuro Surgery



A550 01 091 1053  
8698823352585  
A550 01 091 1054  
8698823352592

DeBakey-Adson  
AO-INS-1053 12,5 cm  
AO-INS-1054 15,0 cm

jaw width 2,0 mm

DeBakey-Adson  
AO-INS-1055 20,0 cm

jaw width 2,0 mm

A550 01 091 1055 8698823352608

DeBakey-Adson  
AO-INS-1056 20,0 cm

jaw width 2,0 mm angled

A550 01 091 1056 8698823352615

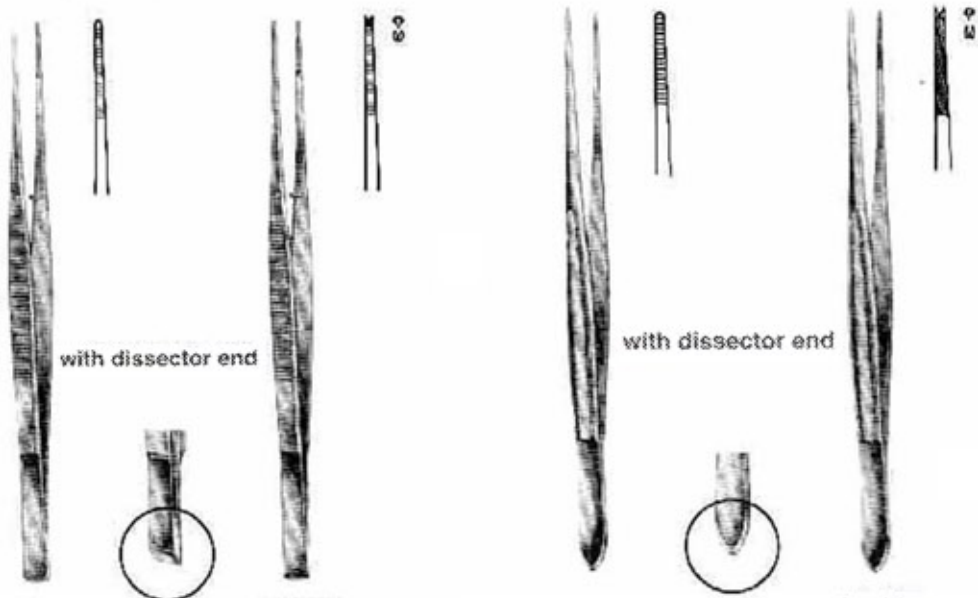

Cushing  
AO-INS-1057 18,0 cm

Cushing  
AO-INS-1058 18,0 cm  
A550 01 091 1058  
8698823352639

Cushing  
AO-INS-1059 18,0 cm  
A550 01 091 1059  
8698823352646

Cushing  
AO-INS-1060 18,0 cm

#### Retractors for spine

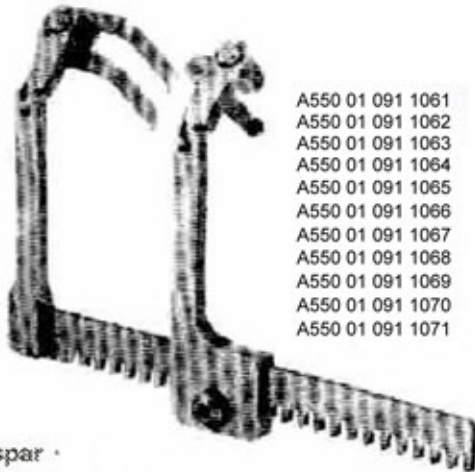

Caspar

A550 01 091 1061	8698823352660
A550 01 091 1062	8698823352677
A550 01 091 1063	8698823352684
A550 01 091 1064	8698823352691
A550 01 091 1065	8698823352707
A550 01 091 1066	8698823352714
A550 01 091 1067	8698823352721
A550 01 091 1068	8698823352738
A550 01 091 1069	8698823352745
A550 01 091 1070	8698823352752
A550 01 091 1071	8698823352769



AO-INS-1072 Counter Retractor, with 5 blades  
AO-INS-1074-78

- AO-INS-1061 Retractor with hook AO-INS-1063 and 5 blades AO-INS-1064-71  
Sperrer allein  
AO-INS-1062 Retractor only

AO-INS-1073 Counter Retractor, only

A550 01 091 1072	8698823352776
A550 01 091 1073	8698823352783
A550 01 091 1074	8698823352790
A550 01 091 1075	8698823352806
A550 01 091 1076	8698823352813
A550 01 091 1077	8698823352820
A550 01 091 1078	8698823352837



Hook 38 mm  
AO-INS-1063

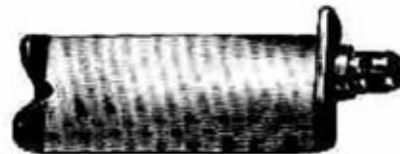

AO-INS-1074	45 x 23 mm
AO-INS-1075	50 x 23 mm
AO-INS-1076	55 x 23 mm
AO-INS-1077	60 x 23 mm
AO-INS-1078	65 x 23 mm



Blades

AO-INS-1064	32 x 22 mm
AO-INS-1065	37 x 22 mm
AO-INS-1066	43 x 22 mm
AO-INS-1067	47 x 22 mm
AO-INS-1068	52 x 22 mm
AO-INS-1069	57 x 22 mm
AO-INS-1070	62 x 22 mm
AO-INS-1071	67 x 22 mm

### Specula for lumbar vertebral operations



Specula

Cat. No.:	Length of blades
AO-INS-1079	45 mm
AO-INS-1080	50 mm
AO-INS-1081	55 mm
AO-INS-1082	60 mm
AO-INS-1083	65 mm

Caspar

A550 01 091 1079	8698823352844
A550 01 091 1080	8698823352851
A550 01 091 1081	8698823352868
A550 01 091 1082	8698823352875
A550 01 091 1083	8698823352882



Specula

Cat. No.:	Length of blades
-----------	------------------

Caspar

A550 01 091 1084	8698823352899	AO-INS-1084	40 mm
A550 01 091 1085	8698823352905	AO-INS-1085	45 mm
A550 01 091 1086	8698823352912	AO-INS-1086	50 mm
A550 01 091 1087	8698823352929	AO-INS-1087	55 mm
A550 01 091 1088	8698823352936	AO-INS-1088	60 mm
A550 01 091 1089	8698823352943	AO-INS-1089	65 mm
A550 01 091 1090	8698823352950	AO-INS-1090	75 mm
A550 01 091 1091	8698823352967	AO-INS-1091	85 mm,



Brun's

AO-INS-1092 0000 A550 01 091 1092 8698823352974	AO-INS-1093 0000 A550 01 091 1093 8698823352981	AO-INS-1094 00 A550 01 091 1094 8698823352998
---	---	---

AO-INS-1095 0 A550 01 091 1095 8698823353001	AO-INS-1096 1 A550 01 091 1096 8698823353018	AO-INS-1097 2 A550 01 091 1097 8698823353025
--	--	--

AO-INS-1098 3 A550 01 091 1098 8698823353032	AO-INS-1099 4 A550 01 091 1099 8698823353049	AO-INS-1100 5 A550 01 091 1100 8698823353056
--	--	--

AO-INS-1101 6  
A550 01 091 1101  
8698823353063



Brun's  
23,0 cm

AO-INS-1102 A550 01 091 1102 8698823353070	AO-INS-1101 A550 01 091 1107 8698823353124
--	--

AO-INS-1103 A550 01 091 1103 8698823353087	AO-INS-1108 A550 01 091 1108 8698823353131
--	--

AO-INS-1104 A550 01 091 1104 8698823353094	AO-INS-1109 A550 01 091 1109 8698823353148
--	--

AO-INS-1105 A550 01 091 1105 8698823353100	AO-INS-1110 A550 01 091 1110 8698823353155
--	--

AO-INS-1106  
A550 01 091 1106  
8698823353117



11 091 1111	8698823353162
11 091 1112	8698823353179
11 091 1113	8698823353186

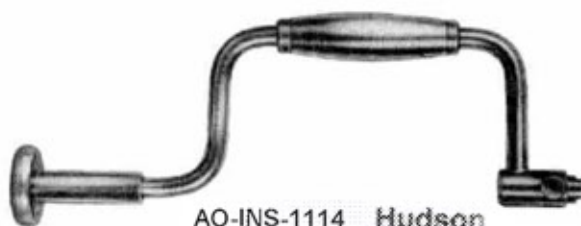

AO-INS-1114 Hudson  
 A550 01 091 1114 8698823353193



AO-INS-1115  
 ø 9 mm  
 A550 01 091 1115  
 8698823353209



AO-INS-1116  
 ø 14 mm  
 A550 01 091 1116  
 8698823353216



AO-INS-1117  
 ø 16 mm  
 A550 01 091 1117  
 8698823353223



AO-INS-1118  
 Cushing  
 A550 01 091 1118  
 8698823353247



AO-INS-1119  
 A550 01 091 1119  
 8698823353254